

## Test Certificate

### Determination of petrographic, mechanical and physical properties of natural stone

Company that required the tests: Palin Granit Oy  
P.O. Box 55  
FIN-20101 TURKU  
Finland

Stone tested: Aurora  
EU Community Trade Mark no. 001805720

Tests performed by: Geological Survey of Finland  
P.O.Box 1237  
70211 Kuopio  
Finland



Hannu Luodes  
Project manager  
Geological Survey of Finland



Geological Survey of Finland  
Eastern Finland Office  
P.O.Box 1237  
70211 Kuopio  
Finland  
Tel. +358 205 5011  
<http://www.gtk.fi>



**GTK**

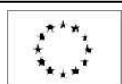

EUROOPAN YHTEISÖ  
Rakennerahastot



**ESR**



ITA-SUOMEN  
LÄÄNNIHALLITUS  
Sivustiosasto

## CONTENTS

1. GENERAL INFORMATION .....	1
2. LOCATION OF THE QUARRY .....	2
3. MINERALOGY .....	3
3.1. SUMMARY OF THE RESULTS .....	3
3.2. DESCRIPTION OF TEST .....	3
3.2.1. Petrographic description, EN 12407:2000 .....	3
4. MECHANICAL AND PHYSICAL PROPERTIES .....	6
4.1. SUMMARY OF THE RESULTS .....	6
4.2. DESCRIPTION OF TESTS .....	7
4.2.1. Water absorption at atmospheric pressure, EN 13755:2002 .....	7
4.2.2. Determination of apparent density and open porosity, EN 1936:1999 .....	8
4.2.3. Freeze/thaw resistance, EN 12371: 2003 .....	9
4.2.4. Flexural strength under concentrated load, EN 12372:1999 .....	9
4.2.5. Compressive strength, EN 1926:1999 .....	11
4.2.6. Abrasion resistance, EN 14157 .....	13
4.2.7. Determination of water absorption coefficient by capillarity, EN 1925:1999 .....	14
4.2.8. Measurement of the slip resistance value (SRV), EN 1342, EN 1341 and EN14231 ...	15
4.2.9. Thermal shock, EN 14066:2003 .....	17
4.2.10. Breaking load at dowel hole, EN 13364:2001 .....	18
4.2.11. Water vapour permeability, EN 12524 .....	19

## 1. GENERAL INFORMATION

The tests performed enable CE marking of the products according to the following harmonized product standards:

EN 1341	Slabs of natural stones for external paving. Requirements and test methods.
EN 1342	Setts of natural stone for external paving. Requirements and test methods
EN 1343	Kerbs of natural stone for external paving. Requirements and test methods
EN 1469	Natural stone products. Slabs for cladding. Requirements
EN 12057	Natural stone products. Modular tiles. Requirements
EN 12058	Natural stone products. Slabs for floors and stairs. Requirements



**GTK**

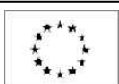

EUROOPAN YHTEISÖ  
Rakennerahastot



**ESR**



FINLANDIN  
LÄÄNNEHALLITUS  
Sivustoyksikö

## 2. LOCATION OF THE QUARRY

Company: Palin Granit Oy  
 P.O. Box 55  
 FIN-20101 TURKU  
 Finland

Stone: **Aurora**

The Aurora quarry is situated in the town of Mäntsälä in southern Finland.

The WGS84 coordinates of the quarry are:  
 N60.560396 E25.436885

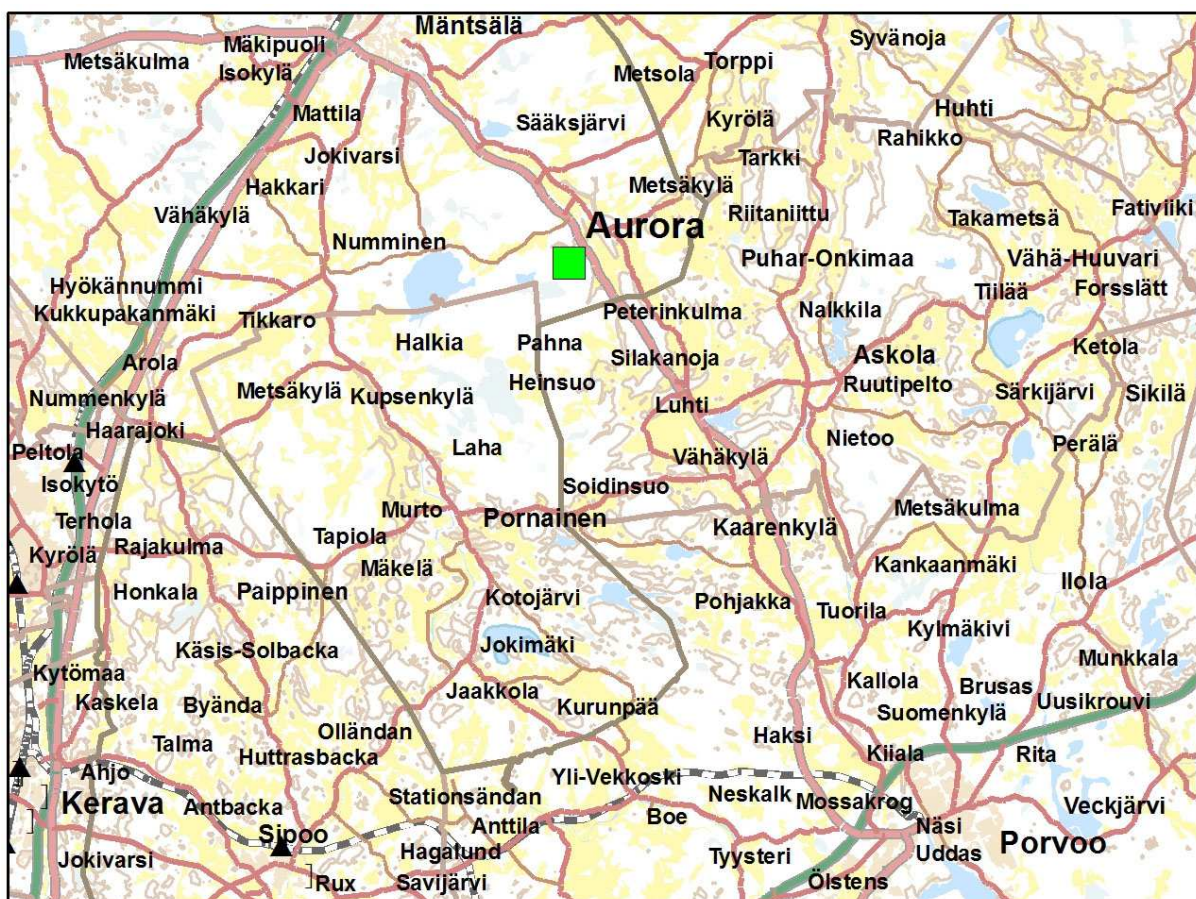
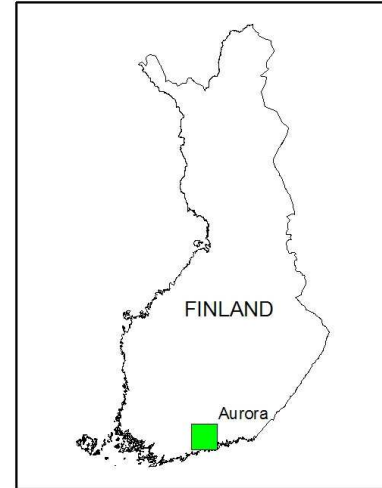

Basemaps: © National Land Survey of Finland, licence no MML/VIR/TIPA/217/10 and Logica Suomi Oy.

### 3. MINERALOGY

#### 3.1. SUMMARY OF THE RESULTS

Producer	Palin Granit Oy
Stone	Aurora
<b>Mineral</b>	<b>Wt%</b>
Plagioclase	44,0
Quartz	25,4
K-feldspar	19,3
Biotite	6,3
Amphibole	3,6
Chlorite	1,3
Others	0,2
<b>Total</b>	<b>100,0</b>

#### 3.2. DESCRIPTION OF TEST

##### 3.2.1. Petrographic description, EN 12407:2000

Company that required the test: Palin Granit Oy  
P.O. Box 55  
FIN-20101 TURKU  
Finland

Specimen code: P 6  
**Aurora**

Laboratory: Geological Survey of Finland / geologist Hannu Luodes  
Research scientist Oleg Knauf

Address: Geological Survey of Finland  
P.O.Box 1237  
70211 KUOPIO  
FINLAND

The date of preparation of the thin section: 25.9.2007  
Dimension of the thin section: 35 x 25 mm

The date of the examination: 4.5.2010

Identification number: GTK P6

**Sample: P 6**Macroscopic description

The colour of the fresh surface is greyish red.

The stone has a migmatitic structure. In the visual appearance can be seen accumulations and veins of feldspar, quartz and biotite, which can have diameter of few centimetres. The texture of the rock is oriented.

Microscopic description

Mineral	Wt % (1)	Dimension (mm)	Habit	Shape	Boundaries	Distribution	Orientation	Remarks
Plagioclase	44,0	0,1-3	Anhedral	Anisometric	Partly definable	Homogeneous	Isotropic	Somewhat altered to sericite
Quartz	25,4	Under 6,6	Anhedral	Anisometric	Partly definable	Homogeneous	Isotropic	
K_feldspar	19,3	0,1-5,4	Anhedral	Anisometric	Partly definable	Homogeneous	Isotropic	Slightly altered to sericite
Biotite	6,3	Under 3,6	Anhedral	Anisometric	Partly definable	Slightly oriented	Isotropic	Somewhat altered to chlorite and magnetite
Amphibole	3,6	Under 2,4	Anhedral	Anisometric	Partly definable	Slightly oriented	Isotropic	Slightly altered to magnetite
Chlorite	1,3	Under 0,5	Anhedral	Anisometric	Not definable	Slightly oriented	Isotropic	
Others	0,2	Under 0,3	Anhedral	Anisometric	Partly definable	Homogeneous	Isotropic	

1) Mineral composition determined by MLA equipment with XMOD\_std method. 21478 measurement points.

In the microscope the rock consists of plagioclase, quartz and K-feldspar grains of various sizes together with slightly oriented biotite grains. Plagioclase, K-feldspar, biotite and amphibole are partly altered.

According to the thin section and sample the rock is **MIGMATITE**.



**GTK**

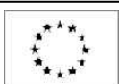

EUROOPAN YHTEISÖ  
Rakennerahastot



**ESR**



ITÄ-SUOMEN  
LÄÄNNIHALLITUS  
Sivistökeskus



## 4. MECHANICAL AND PHYSICAL PROPERTIES

Laboratory: Stone Pole Laboratory, Juuka, Finland / Researcher Mrs Nike Luodes

### 4.1. SUMMARY OF THE RESULTS

	<b>Producer Stone</b>	Palin Granit Oy Aurora
<b>Standard</b>	<b>Test</b>	
EN 13755	Water absorption (%) mean value Standard deviation (%)	0,07 0,00
EN 1936	Apparent Density (kg/m <sup>3</sup> ) mean value density from ... To ... (kg/m <sup>3</sup> ) Standard deviation(kg/m <sup>3</sup> )	2680 2670 to 2690 8
EN 1936	Open porosity (%) mean value standard deviation (%)	0,16 0,01
EN 12372	Flexural strength (MPa) mean value Standard deviation(MPa) Min exp value(MPa)	17,7 2,5 13,2
EN 12371	Flexural strength after frost (MPa) mean value Change in mean flexural strength after 48 cycles (%) Standard deviation(MPa) Min exp value(MPa)	16,1 9,0 3,1 10,7
EN 1926	Compression strength (MPa) mean value Standard deviation(MPa) Min exp value(MPa)	194 29,9 130
EN 12371	Compression strength after frost (MPa) mean value Standard deviation(MPa) Min exp value(MPa)	204 27,2 145
EN 1925	Water absorption by Capillarity C (g/m <sup>2</sup> s <sup>0,5</sup> ) mean value Standard deviation(g/m <sup>2</sup> s <sup>0,5</sup> )	0,068 0,022
EN 14231 and CE standards of reference	Skid resistance - dry polished mean value Skid resistance - wet polished mean value Skid resistance - dry honed mean value Skid resistance - wet honed mean value	55,1 6,5 56,2 35,2
EN 14157 and CE standards of reference	Abrasion resistance (mm) mean value	18
EN 13364	Resistance at the anchoring system Mean breaking Load(N) Min exp value (N) Standard deviation (N) d1(mm) bA(mm)	2850 2365 250 10,8 42,5
EN 14066	Resistance to Thermal shock visual changes max Mass change (%) max res. Freq. change (%)	no 0,07 7,2
EN 1925	Water absorption by Capillarity C (g/m <sup>2</sup> s <sup>0,5</sup> ) parallel mean value Standard deviation	no directions
EN 12524	water vapour resistance factor $\mu$ dry water vapour resistance factor $\mu$ wet	10000 10000

## 4.2. DESCRIPTION OF TESTS

### 4.2.1. Water absorption at atmospheric pressure, EN 13755:2002

The water absorption test has been performed following the standard SFS-EN 13755:2002 "Natural stone test methods. Determination of water absorption at atmospheric pressure"

The specimens has been dried at constant mass, weighted, immersed gradually in water at atmospheric pressure and weighted in air when saturated.

The water absorption has been calculated as  $100 \cdot (m_s - m_d) / m_d$

$m_d$ : 2<sup>nd</sup> dry weigh (+24 h)

$m_s$ : saturated weigh

The mean value, the standard deviation and the coefficient of variation are given besides the uncertainty of the result.

Number and Dimensions (mm)- 6 specimens :50 mm x 50 mm x 50mm
Surface finish : saw

### RESULTS:

<i>Specimen codes:</i>	P6/1	P6/2	P6/3	P6/4	P6/5	P6/6
$m_d$ (g)	389,13	388,71	388,02	387,36	384,59	389,94
$m_s$ (g)	389,39	388,97	388,28	387,65	384,85	390,18
Water absorption $A_b$ (%)	0,1	0,1	0,1	0,1	0,1	0,1

<b>Mean value m (%)</b>	<b>0,07</b>	Standard dev. s (%)	0,00	Coef. of variation v	0,06
-------------------------	-------------	---------------------	------	----------------------	------

Uncertainty $\Delta A_b$ (%)	0,00
------------------------------	------

#### 4.2.2. Determination of apparent density and open porosity, EN 1936:1999

The apparent density and open porosity test has been performed following the standard SFS-EN 1936:1999 "Natural stone test method. Determination of real density and apparent density, and of total and open porosity".

The specimens have been dried at constant mass, weighted ( $m_d$ ), cooled down in a desiccator, put under vacuum for 1 day, introduced water under vacuum and let them there for 1 day, stop the vacuum and let them under water at atmospheric pressure for 1 day. Then the specimens have been weighted in water ( $m_h$ ) and in air ( $m_s$ ).

The apparent density has been calculated as:  $\rho_{rh} * m_d / (m_s - m_h)$  in which  $\rho_{rh}$  is the density of water at 20°C = 998 kg/m<sup>3</sup>. The results of the specimens have been approximated to the nearest 10kg/m<sup>3</sup> and also the average value has the same approximation.

The open porosity has been calculated as:  $100 * (m_s - m_d) / (m_s - m_h)$  and the results and the average value have been approximated to the nearest 0,1%.

The mean value, the standard deviation and the coefficient of variation are given besides the uncertainty of the result.

Number and Dimensions (mm)- 6 specimens :50 mm x 50 mm x 50mm
Surface finish : saw

<i>Specimen codes:</i>	P6/1	P6/2	P6/3	P6/4	P6/5	P6/6
$m_d$ (g)	389,18	388,76	388,06	387,43	384,62	389,99
$m_h$ (g)	244,88	244,29	243,48	242,79	241,31	244,18
$m_s$ (g)	389,44	388,99	388,30	387,66	384,86	390,21
<b>Apparent density</b> $r_b$ (kg/m <sup>3</sup> )	2690	2680	2670	2670	2670	2670
Mean value m (kg/m <sup>3</sup> )	2680	Stand. deviation s (kg/m <sup>3</sup> )	8	Coefficient of variation v	0,00	
<b>Open porosity</b> $p_o$ (%)	0,2	0,2	0,2	0,2	0,2	0,2
Mean value m (kg/m <sup>3</sup> )	0,16	Stand. deviation s (kg/m <sup>3</sup> )	0,01	Coefficient of variation v	0,06	

#### 4.2.3. Freeze/thaw resistance, EN 12371: 2003

The frost resistance is performed in accordance with EN 12371: 2003 , with 48 cycles of frost in air and thaw in water. The temperature range is shown in the standard. At the end the specimens are dried at constant mass at 70°C. The frost test is stopped if the specimen broke during the cycles.

#### 4.2.4. Flexural strength under concentrated load, EN 12372:1999

The flexural strength test has been performed according to the standard SFS-EN 12372:1999

The load has been applied at a uniform rate following the scheme as shown in figure. The specimen has been brought to rupture and the maximum load has been recorded to the nearest 10 N. The dimensions that have been measured are the following:

l is the distance between the supporting rollers

B is the width of the specimen adjacent to the plane of fracture recorded to the nearest 0,1 mm.

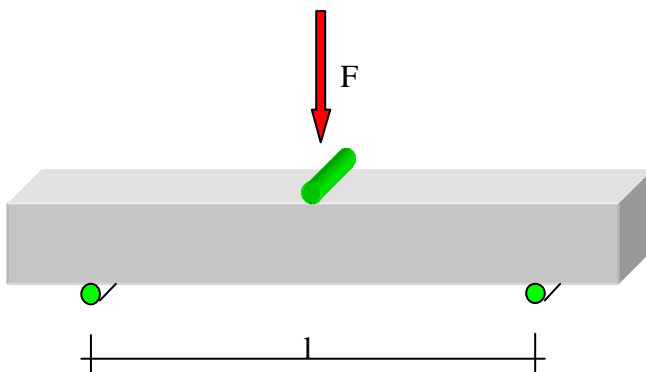

H is the thickness of the specimen adjacent to the plane of fracture recorded to the nearest 0,1 mm

The flexural strength has been calculated as:  $3Fl/2BH^2$  and has been expressed to the nearest 0,1 MPa.

In the results are given the average, the standard deviation and the minimum expected value.

After the test:

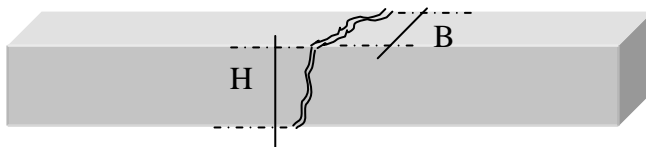

FRESH MATERIAL  
RESULTS OF FLEXURAL STRENGTH

Specimens: 10 prisms: 60x50x300 mm

<i>Specimen codes:</i>	P6/31	P6/32	P6/33	P6/34	P6/35	P6/36	P6/37	P6/38	P6/39	P6/40
Span l (mm)	250	250	250	250	250	250	250	250	250	250
Width B (mm)	60,33	60,58	60,90	60,20	60,24	60,99	60,22	60,85	60,89	61,04
Thickness H (mm)	54,18	54,82	55,65	54,94	54,96	54,24	54,00	54,84	54,82	54,42
Breaking load F (N)	7090	9230	9875	8003	8386	8380	8444	8181	6956	11098
Flex. strength $R_{ff}$ (MPa)	15,0	19,0	19,6	16,5	17,3	17,5	18,0	16,8	14,3	23,0

<b>Mean <math>m</math> (MPa)</b>	<b>17,7</b>	Standard deviation $s$ (MPa)	2,5	Coefficient of variation $v$	0,14
----------------------------------	-------------	------------------------------	-----	------------------------------	------

MATERIAL AFTER FROST CYCLES  
RESULTS OF FLEXURAL STRENGTH:

Specimens: 10 prisms: 60mm x 50mm x 300 mm, surface sawed

<i>Specimen codes:</i>	P6/41	P6/42	P6/43	P6/44	P6/45	P6/46	P6/47	P6/48	P6/49	P6/50
Span l (mm)	250	250	250	250	250	250	250	250	250	250
Width B (mm)	60,51	60,68	60,51	60,42	60,66	60,70	60,31	60,42	60,33	60,53
Thickness H (mm)	54,55	54,81	55,25	55,15	54,40	54,90	53,96	54,26	53,81	55,16
Breaking load F (N)	5471	8578	7133	8520	7493	7144	10773	7795	7739	6590
Flex. strength $R_{ff}$ (MPa)	11,4	17,6	14,5	17,4	15,7	14,6	23,0	16,4	16,6	13,4

<b>Mean <math>m</math> (MPa)</b>	<b>16,1</b>	Standard deviation $s$ (MPa)	3,1	Coefficient of variation $v$	0,19
----------------------------------	-------------	------------------------------	-----	------------------------------	------

#### 4.2.5. Compressive strength, EN 1926:1999

The compressive strength test has been performed according to the standard SFS-EN 1926:1999

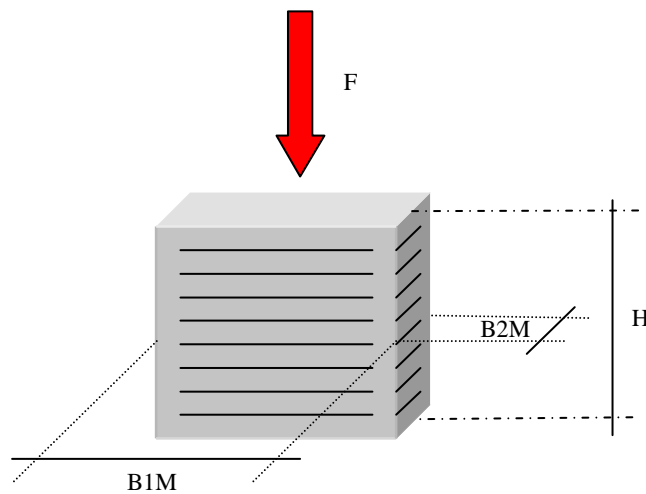

The specimens have been dried at constant mass.

Before to perform the test the dimensions of the specimens have been measured:

H is the height of the specimen

B1M and B2M are the cross sectional dimensions:

B1M is obtained by averaging 2 measures taken in the upper and lower face of the cube in one direction and is calculated to the nearest 0,1 mm

B2M is obtained by averaging 2 measures

taken in the upper and lower face of the cube in the direction perpendicular to the previous one and is calculated to the nearest 0,1 mm

$l_m$  is obtaining averaging B1M and B2M.

Then the load has been applied continuously at a constant stress rate until the brake happen, and the maximum load has been recorded (F), approximated to the nearest 1kN.

The uniaxial compressive strength (R) of the specimen is given by the ratio:  $F/(l_m * l_m)$

The Average value, the standard deviation and the coefficient of variation are as well indicated.

FRESH MATERIAL  
RESULTS OF COMPRESSIVE STRENGTH:

**Specimens:** 6 prisms: 70mm x 70mm x 70 mm, surface sawed

<i>Specimen codes:</i>	P6/11	P6/12	P6/13	P6/14	P6/15	P6/16
Average length $l_m$ (mm)	70,7	70,5	70,2	69,2	69,7	69,5
Breaking load F (kN)	1083,0	995,3	720,9	1040,5	1041,4	808,1
<b>Compressive strength R (MPa)</b>	217	200	146	217	214	167

<b>Mean <math>m</math> (MPa)</b>	<b>194</b>	Standard deviation $s$ (MPa)	29,9	Coefficient of variation $v$	0,155
----------------------------------	------------	------------------------------	------	------------------------------	-------

RESULTS OF COMPRESSIVE STRENGTH AFTER FROST CYCLES:

**Specimens:** 6 prisms: 70mm x 70mm x 70 mm, surface sawed

<i>Specimen codes:</i>	P6/21	P6/22	P6/23	P6/24	P6/27	P6/26
Average length $l_m$ (mm)	70,5	69,3	70,5	69,9	69,1	70,5
Breaking load F (kN)	1062,9	742,7	1092,9	945,0	1022,5	1147,8
<b>Compressive strength R (MPa)</b>	214	155	220	193	214	231

<b>Mean <math>m</math> (MPa)</b>	<b>204</b>	Standard deviation $s$ (MPa)	27,2	Coefficient of variation $v$	0,133
----------------------------------	------------	------------------------------	------	------------------------------	-------

#### 4.2.6. Abrasion resistance, EN 14157

Test performed following: EN 14157 Natural stone test methods - Determination of the abrasion resistance

Scheme of the apparatus:

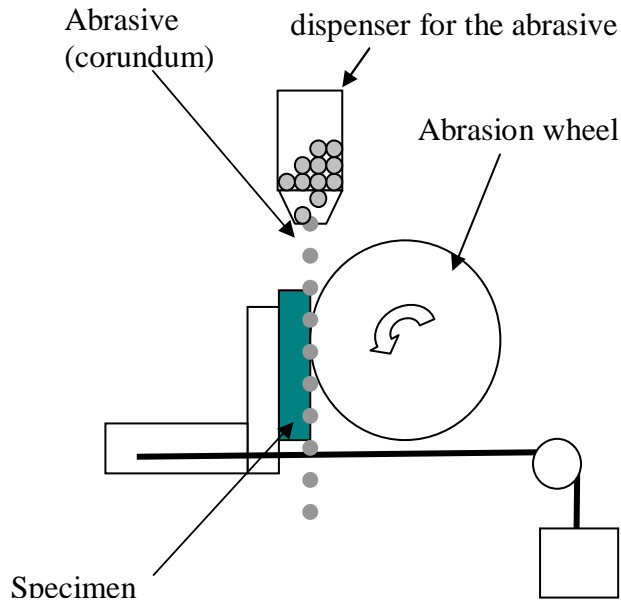

The specimen is painted and is placed on the holding part, the dispenser is open and the abrasive starts to fall down, the wheel starts to turn. After 75 rotations it stops and the specimen is taken out. The print (groove) given by the wheel is measured.

The groove has a rectangle shape and the width is measured in the middle section after to have drawn the two longitudinal lines (The two external points of the groove are A and B).

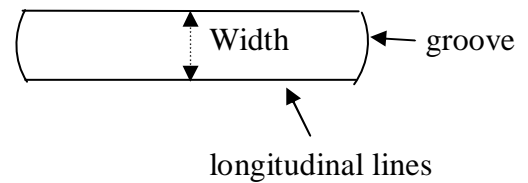

Specimens: 6 specimens 110x160x30mm

code specim.	P6/81	P6/82	P6/83	P6/84	P6/85	P6/86
Groove length AB (mm)	16,17	16,95	17,96	17,02	17,15	16,95
Abrasion resistance $R_i$ (mm)	18	17	18	18	18	17

Mean value (m): 18 mm



#### 4.2.7. Determination of water absorption coefficient by capillarity, EN 1925:1999

Test performed following the European standard SFS- EN 1925:1999

Description of the test:

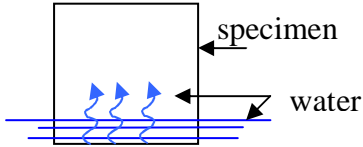

The specimens have been dried at constant mass, measured the dimension of one base, weighed and immerse in  $(3\pm 1)$ mm of water the base measured. Each specimen has been taken out of water, damped and weighted at determined time intervals.

The results are put on a graph in which it is shown the mass of water absorbed (g) divided by the area of the immersed base ( $\text{m}^2$ ) in function of the time (s). For the point of the first part of the graph is controlled that the coefficient of correlation between the measures performed and the regression line is  $>0,90$  or  $0,95$  depending on how many measures have been taken.

The coefficient of water absorption by capillarity is represented by the slope of the regression line and it can be calculated as:  $m_i - m_d / A t_i^{0,5}$ , in which:

$m_d$  mass of dried specimen

$m_i$  successive masses of specimen during testing

A area of the immersed base of the specimen

$t_i$  times from beginning of the test until the time in which the masses are measured

The average and the standard deviation are given as a result.

Specimens: 6 specimens 70x70x70mm

Specimen codes:	P6/11	P6/12	P6/13	P6/14	P6/15	P6/16
Surface A ( $\text{mm}^2$ )	4998,45	4980,12	4915,09	4794,09	4865,32	4839,87
C ( $\text{g}/\text{m}^2\text{s}^{0,5}$ )	0,0	0,1	0,1	0,1	0,1	0,1
C. correlation r	0,990	0,861	0,991	0,948	0,938	0,829

Average m ( $\text{g}/\text{m}^2\text{s}^{0,5}$ )	<b>0,068</b>	standard dev. ( $\text{g}/\text{m}^2\text{s}^{0,5}$ )	0,022	Coefficient of variation v	0,320
---	--------------	---	-------	----------------------------	-------

Water absorption by Capillarity C ( $\text{g}/\text{m}^2\text{s}^{0,5}$ ) parallel: no directions

#### 4.2.8. Measurement of the slip resistance value (SRV), EN 1342, EN 1341 and EN14231

Test as in EN 1342 and EN 1341 and as in EN14231 in wet and dry conditions:

In the Dry test the specimens are kept dry and the test is performed in dry conditions, in the Wet test the specimens are immersed in water at 20°C for more than 2 hours and the test is performed in wet condition. The position of the pendulum tester is controlled adjusting the bubble level and the zero of the apparatus is calibrated. The specimen is placed and the height of the pendulum arm is controlled. In the dry test the pendulum is released and the value on the scale is read.

In the wet test the surface of the stone is spread of water as the surface of the rubber slider, then the pendulum is released and the value on the scale is read.

For each specimen are done 5 or 3 measurements in 2 opposite directions and written the means values on both the directions. The value of the specimen will be the mean value of the 2 values recorded.

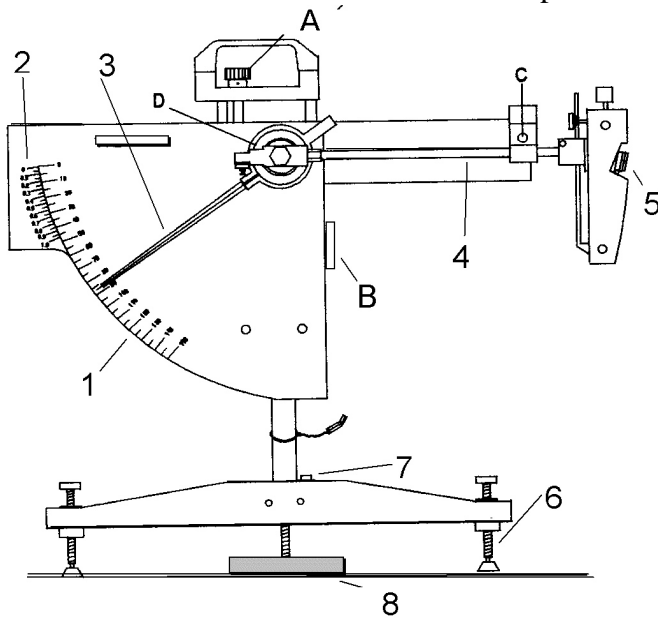

- 1 scale (126 mm sliding length)
- 2 scale (76 mm sliding length)
- 3 Pointer
- 4 Pendulum
- 5 Rubber Slider
- 6 Levelling Screw
- 7 Spirit Level
- 8 Test Specimen Holder
- 9 Vertical Adjustment Screw

- A Screw for the vertical adjustment
  - B Screw for block or release the vertical adjustment
  - C Button for release the pendulum
  - D Friction for calibrate the zero of the apparatus
- The slider used has dimensions: 76 mm wide

## RESULTS SLIP RESISTANCE TEST POLISHED SURFACE - DRY

<i>Code of specimens:</i>	P6/61	P6/62	P6/63	P6/64	P6/65	P6/66
Average in the direction a	53,00	56,60	48,00	51,20	64,40	63,00
Average in the direction b	52,60	50,20	45,60	49,20	63,40	63,80
Rounded average on the slab	52,8	53,4	46,8	50,2	63,9	63,4

**Mean value: 55,1**

## RESULTS SLIP RESISTANCE TEST POLISHED SURFACE - WET

<i>Code of specimens:</i>	P6/61	P6/62	P6/63	P6/64	P6/65	P6/66
Average in the direction a	6,40	7,00	7,20	6,40	5,00	5,60
Average in the direction b	6,40	8,80	6,80	6,80	5,60	5,60
Rounded average on the slab	6,4	7,9	7,0	6,6	5,3	5,6

**Mean value: 6,5**

## RESULTS SLIP RESISTANCE TEST HONED SURFACE - DRY

<i>Code of specimens:</i>	P6/71	P6/72	P6/73	P6/74	P6/75	P6/76
Average in the direction a	58,20	56,40	57,80	55,60	58,20	52,00
Average in the direction b	56,20	58,80	58,80	54,60	56,40	51,20
Rounded average on the slab	57,2	57,6	58,3	55,1	57,3	51,6

**Mean value: 56,2**

## RESULTS SLIP RESISTANCE TEST HONED SURFACE - WET

<i>Code of specimens:</i>	P6/71	P6/72	P6/73	P6/74	P6/75	P6/76
Average in the direction a	35,00	34,80	35,20	35,60	35,60	36,60
Average in the direction b	34,60	35,00	34,20	34,40	36,20	35,60
Rounded average on the slab	34,8	34,9	34,7	35,0	35,9	36,1

**Mean value: 35,2**

#### 4.2.9. Thermal shock, EN 14066:2003

*Reference to standard SFS-EN 14066:2003 Natural stone test method- Determination of thermal shock*

The stone is dried to constant mass and weighed ( $m_0$ ), the fundamental resonance frequency is measured according to EN 14146. Twenty cycles of heat at 105°C and immersion in water at 20°C are performed and the tiles are visually inspected and reweighed ( $m_f$ ), the fundamental resonance frequency is measured again. A visual description of the tiles, the evaluation of change of mass ( $\Delta m$ ) and of change of dynamic elastic modulus are performed.

$$\Delta m (\%) = (m_f - m_0 / m_0) * 100$$

$$\Delta E_d (\%) = (E_{d0} - E_{df} / E_{d0}) * 100$$

#### VISUAL DESCRIPTION

Visual changes	No
Max Mass change (%)	0,07
Max res. Freq. change (%)	7,2

**GTK**EUROOPAN YHTEISÖ  
RakennerahastotFINLANDIN  
LÄÄNNEHALLITUS  
Sivustoyksikkö

#### 4.2.10. Breaking load at dowel hole, EN 13364:2001

Reference standard EN13364:2001 “Natural stone Test methods- Determination of the breaking load at dowel hole”

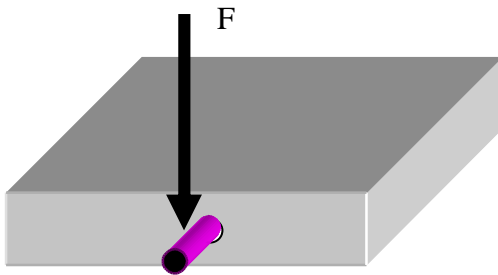

The specimen has dimension 200x200x30 mm. A hole of 10 mm is made on one side, and a dowel of 6mm diameter is placed with Cement I 52,5R. A force is applied until the specimen brake.

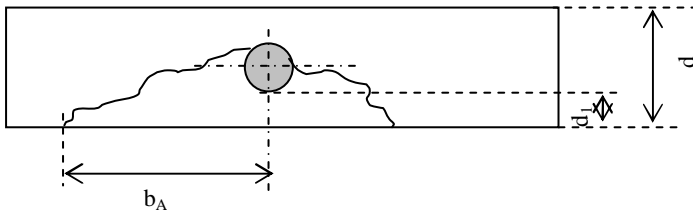

At the end is recorder

- The breaking load ( $F$ ) in (N) approximated to the nearest 50N
- the distance from the hole to the face in the direction of the force ( $d_1$ ) in (mm), approximate to 1,0 mm
- maximum distance of the centre of the hole to the fracture edges ( $b_A$ ) in (mm), approximate to 1,0 mm

The mean load and the standard deviation are given as well in the results.

Code spec.	P6/81	P6/82	P6/83	P6/84	P6/85	P6/86	P6/87	P6/88	P6/89	P6/90
$d_1$ (mm)	10,42	10,02	10,48	10,69	11,64	11,73	10,58	10,93	10,58	11,12
$b_A$ (mm)	46,31	41,12	38,38	27,49	42,74	76,27	37,07	39,40	38,40	37,75
$F$ (N)	3198,23	2598,19	2833	2531,86	3035,22	2737,1	3298,69	2629,72	2864,3	2818,29
Breaking thickness $d_1$ (mm)	10,4	10,0	10,5	10,7	11,6	11,7	10,6	10,9	10,6	11,1
Max. fracture length $b_A$ (mm)	46,3	41,1	38,4	27,5	42,7	76,3	37,1	39,4	38,4	37,8

Average max. fracture length $b_A$ (mm)	42,5	Average breaking thickness $d_1$ (mm)	10,8
---	------	---------------------------------------	------

Breaking load $F$ (N)	3200	2600	2850	2550	3050	2750	3300	2650	2850	2800
-----------------------	------	------	------	------	------	------	------	------	------	------

Mean $m$ (N)	2850	Standard deviation $s$ (N)	250	Coefficient of variation $v$	0,09
--------------	------	----------------------------	-----	------------------------------	------

#### 4.2.11. Water vapour permeability, EN 12524

From the tables of the EN 12524 and after have determined the apparent density of the material can be interpolated the vapour resistance factor in dry and wet conditions.

Classification:	density $\rho$ , (kg/m <sup>3</sup> )	Design thermal conductivity ( $\lambda$ ), W/(mK)	Specific heat capacity $c_p$ J/(kgK)	Water vapour resistance factor $\mu$	
				DRY	WET
STONE					
Natural crystalline rock	2800	3,5	1000	10000	10000
natural sedimentary rock	2600	2,3	1000	250	200
natural sedimentary rock light	1500	0,85	1000	30	20
natural, porous, eg lava	1600	0,55	1000	20	15
Basalt	2700 - 3000	3,5	1000	10000	10000
gneiss	2400 - 2700	3,5	1000	10000	10000
granite	2500 - 2700	2,8	1000	10000	10000
marble	2800	3,5	1000	10000	10000
slate	2000 - 2800	2,2	1000	1000	800
limestone, extra soft	1600	0,85	1000	30	20
limestone soft	1800	1,1	1000	40	25
limestone, semihard	2000	1,4	1000	50	40
limestone hard	2200	1,7	1000	200	150
limestone extra hard	2600	2,3	1000	250	200
snadstone (silica)	2600	2,3	1000	40	30
natural pumice	400	0,12	1000	8	6
artificial stone	1750	1,3	1000	50	40

Water vapour resistance factor is the important one to evaluate the water permeability of the material:

dry conditions	wet conditions
$\mu = 10000$	$\mu = 10000$

The water vapour resistance factor is independent from the barometric pressure, since the barometric pressure of the air and of the material are considered the same. It is therefore a parameter of reference for calculations related to buildings.

To find the water vapour permeability of the material can be referred to SFS EN ISO 12572 where:

$$\text{Water vapour permeability of material} = \frac{\text{Water vapour permeability of air}}{\mu}$$

The water vapour permeability of air can be evaluated from the following graphic (referred to 23° C).

